

Panasonic

Panasonic

HC2E-H-AC48V-F

Part Number:
 Manufacturer / Brand:
 Mombamomba ny vokatra
 Datasheets:
 RoHS Status
 Ship From
 Shipment Way

HC2E-H-AC48V-F
 Panasonic
 HC RELAY 2 FORM C 48VAC
[PDF HC2E-H-AC48V-F.pdf](#)
 Lead free / RoHS compliant
 Hong Kong
 DHL/Fedex/TNT/UPS/EMS

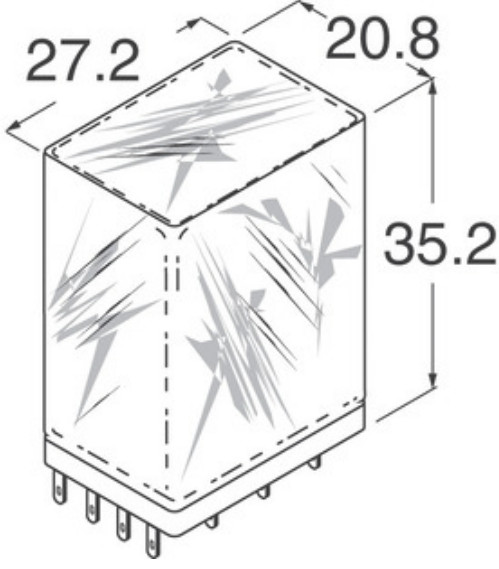

MANGATAHA FAMPISEHOANA

Mety ho sary ny sary. Jereo manokana ny tsipiriany momba ny vokatra.











Specifications of HC2E-H-AC48V-F

PART NUMBER	HC2E-H-AC48V-F
MANUFACTURER	Panasonic
DESCRIPTION	HC RELAY 2 FORM C 48VAC
LEAD FREE STATUS / ROHS STATUS	Lead free / RoHS compliant
TAKELA-DAZA	PDF HC2E-H-AC48V-F.pdf
SERIES	*
NY HAAVON'NY FAHITAN-TORY (MSL)	1 (Unlimited)
LEAD FREE STATUS / ROHS STATUS	Lead free / RoHS Compliant
DETAILED DESCRIPTION	Relay Coil

Related Tags

Panasonic HC2E-H-AC48V-F	Distributor HC2E-H-AC48V-F	Mpamatsy HC2E-H-AC48V-F
Vidiny HC2E-H-AC48V-F	Sary HC2E-H-AC48V-F	Sary HC2E-H-AC48V-F
HC2E-H-AC48V-F Datasheet PDF	HC2E-H-AC48V-F Download Datasheet	HC2E-H-AC48V-F Datasheet
Saham HC2E-H-AC48V-F	Buy HC2E-H-AC48V-F	Vidio ny Panasonic HC2E-H-AC48V-F
Panasonic HC2E-H-AC48V-F	Mpamatsy Panasonic	Distributor Panasonic
Panasonic HC2E-H-AC48V-F	Panasonic - Consumer Division HC2E-H-AC48V-F	Panasonic - Consumer Electronics Corp. HC2E-H-AC48V-F
Panasonic Battery Group HC2E-H-AC48V-F	Panasonic Electric Works - ACSD HC2E-H-AC48V-F	Panasonic Electronic Components - Semiconductor Pr HC2E-H-AC48V-F
Panasonic - ATG HC2E-H-AC48V-F	Panasonic - BSG HC2E-H-AC48V-F	Panasonic - DTG HC2E-H-AC48V-F
Panasonic Electric Works HC2E-H-AC48V-F	Panasonic Electronic Components HC2E-H-AC48V-F	Panasonic Industrial Automation Sales HC2E-H-AC48V-F
Panasonic Semiconductor HC2E-H-AC48V-F		

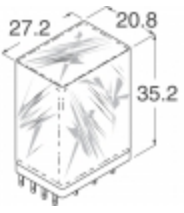
Related Products

 <p>HC2E-H-AC6V-F Manufacturers: Panasonic Description: HC RELAY 2 FORM C 6VAC Ao amin'ny staoky: Out stock RFQ</p>	 <p>HC2E-H-DC110V-F Manufacturers: Panasonic Description: HC RELAY Ao amin'ny staoky: Out stock RFQ</p>
 <p>HC2E-H-AC6V Manufacturers: Panasonic Description: RELAY GENERAL PURPOSE DPDT 3A 6V Ao amin'ny staoky: Out stock RFQ</p>	 <p>HC2E-H-AC24V Manufacturers: Panasonic Description: RELAY GEN PURPOSE DPDT 3A 24V Ao amin'ny staoky: Out stock RFQ</p>
 <p>HC2E-H-AC200V-F Manufacturers: Panasonic Description: RELAY GEN PURP DPDT 200VAC Ao amin'ny staoky: Out stock RFQ</p>	 <p>HC2E-H-AC24V-F Manufacturers: Panasonic Description: HC RELAY 2 FORM C 24VAC Ao amin'ny staoky: Out stock RFQ</p>
 <p>HC2E-H-DC100V-F Manufacturers: Panasonic Description: RELAY GEN PURP DPDT 100VDC Ao amin'ny staoky: Out stock RFQ</p>	 <p>HC2E-H-DC12V Manufacturers: Panasonic Description: RELAY GEN PURPOSE DPDT 3A 12V Ao amin'ny staoky: Out stock RFQ</p>
 <p>HC2E-H-DC110V Manufacturers: Panasonic Description: RELAY GEN PURPOSE DPDT 3A 110V Ao amin'ny staoky: Out stock RFQ</p>	 <p>HC2E-H-AC240V-F Manufacturers: Panasonic Description: HC RELAY 2 FORM C 240VAC Ao amin'ny staoky: Out stock RFQ</p>
 <p>HC2E-H-AC240V Manufacturers: Panasonic Description: RELAY GEN PURPOSE DPDT 3A 240V Ao amin'ny staoky: Out stock RFQ</p>	 <p>HC2E-H-AC48V Manufacturers: Panasonic Description: RELAY GEN PURPOSE DPDT 3A 48V Ao amin'ny staoky: Out stock RFQ</p>